



TMdrive®-50 Product Application Guide

Medium Voltage 3-Level IGBT System Drive

metals

cranes

mining

testing

oil & gas

renewable
energy

power
generation

cement

The family of TMdrive[®] ac system drives is targeting specific customer requirements for:

- High reliability
- Simple configuration and maintenance
- Low cost of ownership

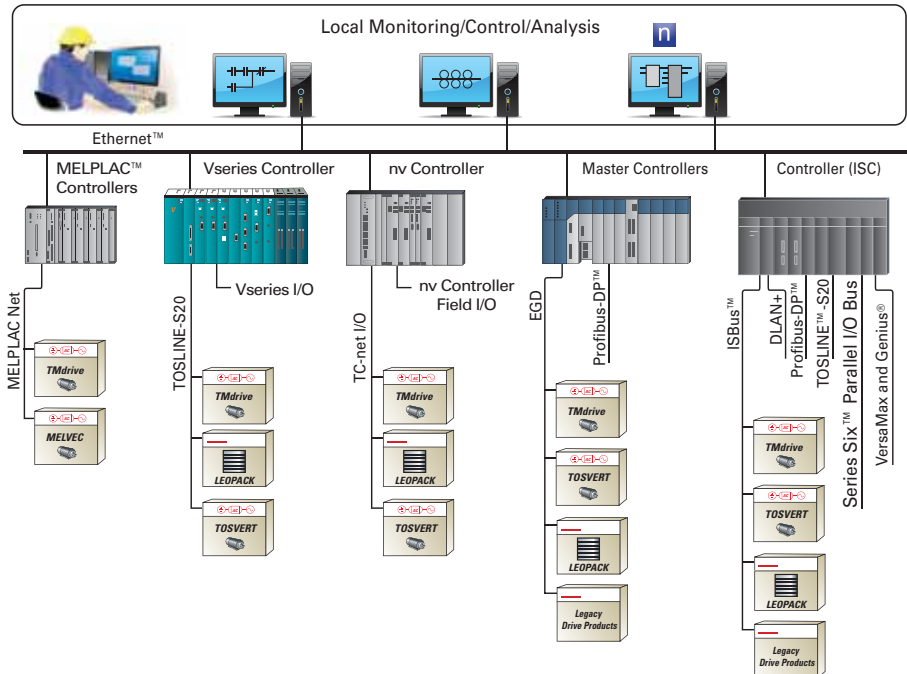

IGBT Technology Dramatically Lowers Cost of Ownership

The Insulated Gate Bipolar Transistor (IGBT) is used in the converter and inverter. The following set of features and associated benefits details how this device lowers your cost of ownership versus previous main drive technology.



Features

The control signal is voltage, not current

High switching speeds less than 2 μ sec

Simple switching circuitry

Benefits

The IGBT requires very low power to switch so control circuits are small, with few components and therefore low failure rate

Very low switching losses and accurate control

Gate driver hardware is compact. Careful design has allowed traditional IGBT snubber components to be removed

Bringing Reliable Control To System Applications

High-power, precision-controlled processes are ideally suited for the TDrive[®]-50 with its efficient high current IGBT power devices and control cards common to the drive family. Flexible arrangement of converter, inverter and cooling units allows for maximum power density, resulting in minimum floor space, and installation cost.



Coordinated drive systems are an integral part of numerous manufacturing processes in the metals industry. TDrive system drives address all of these applications with a robust control platform and a common Microsoft Windows-based tool. The tool supports local and remote connectivity, and is an invaluable asset for system and process analysis.

Due to its high reliability, simplicity of design and high efficiency, the TDrive-50 is perfect for compressor, fan and pumping applications. It provides accurate speed control and high efficiency while eliminating the need for high maintenance mechanical flow control devices. The TDrive-50 is also well suited for applications like grinding mills and mine hoists, where high overloads and impacts are a part of everyday operations.



State-of-the-Art Technology:

- High Voltage Insulated Gate Bipolar Transistors (IGBT) – based converter provides power to the process at unity power factor and low harmonics
- Water-cooling technology for the power bridge reduces the footprint of the equipment saving valuable space in your factory
- Modular design for power bridge minimizes the time required for any maintenance activities

Control Cabinet 3 MVA Converter 3 MVA Inverter

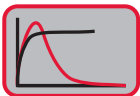
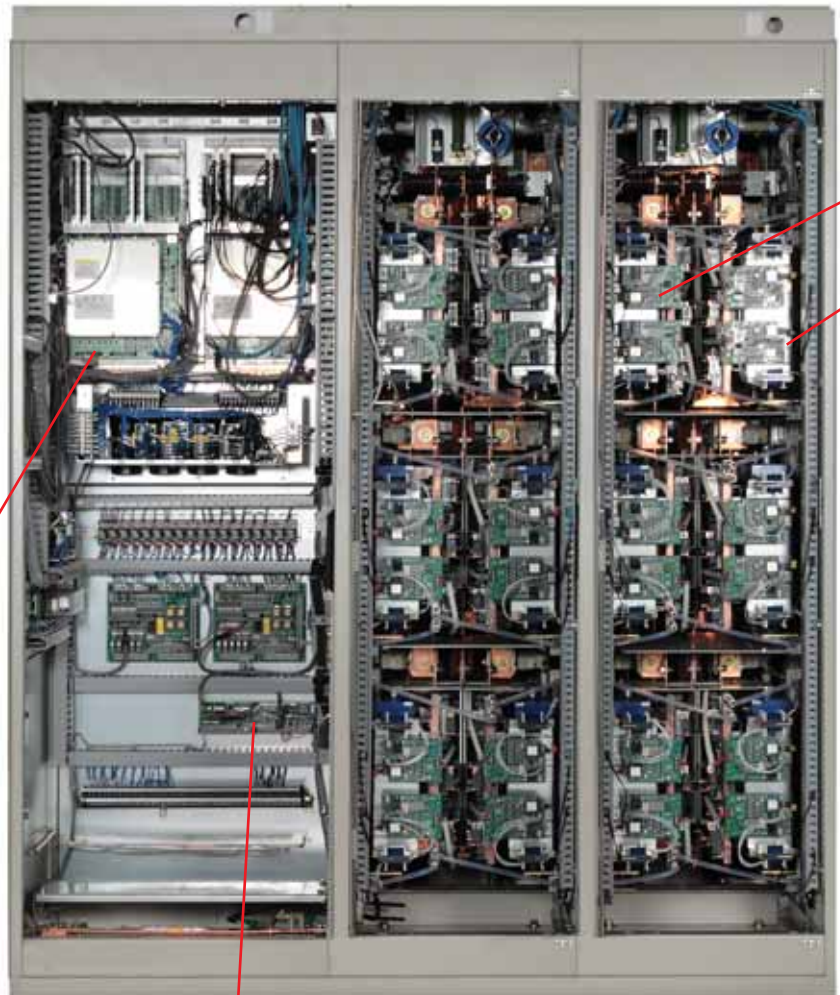

Control Functions

Each inverter and regenerative converter shares a common set

of control boards. The primary control board performs several functions:

- Speed and torque regulation
- Sequencing
- I/O mapping
- Diagnostic data gathering

A mounting bracket is provided for an optional LAN interface board.



I/O Board

All TMdrive products share a common I/O board. The I/O board supports an encoder, 24 V dc I/O, 115 V ac inputs, and analog I/O, standard. In addition, a resolver interface option can be provided. All I/O are terminated to a two-piece modular terminal block for ease of maintenance.

Typical Inverter Waveforms

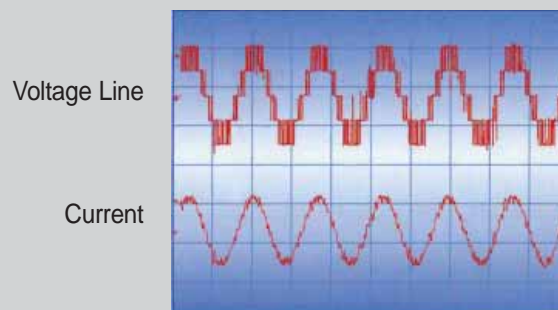

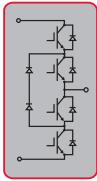

IGBT Three-Level Phase Leg Assembly

The drive has a total of six phase leg assemblies. These are organized as twelve identical half legs each containing two IGBT switches.

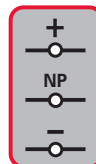

dc Bus

The converter generates dc power for the inverter. The inverter then creates variable frequency ac power to control the induction or synchronous motor. The dc power between the converter and inverter is conveyed on a solid copper bus behind the phase leg assemblies in both cabinets. For common bus systems this bus is extended to adjacent cases.

Inverter Back View

Converter Back View



Main Capacitors

Dry Type Film capacitors are used to provide long life under all service conditions and duty cycles.

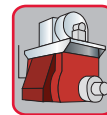

Main Power

3-Phase motor and transformer are made in the rear. Bottom entry is supported.



Cooling Water Interface

JIS-10K40A fittings are provided for connecting cooling water for de-ionized cooling loop. Water interface shown here is for "separate" type water conditioner.

Drive Details

TMdrive-50 Frame 3000

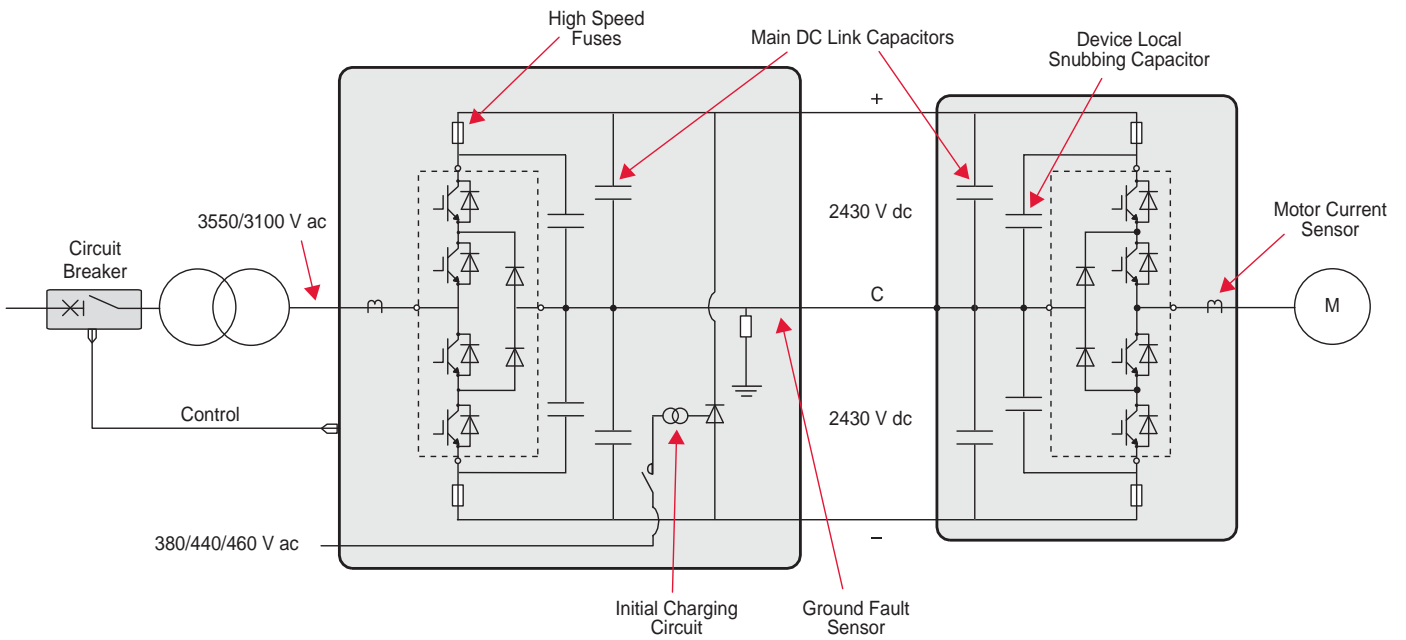

TMdrive-50 Frame 6000

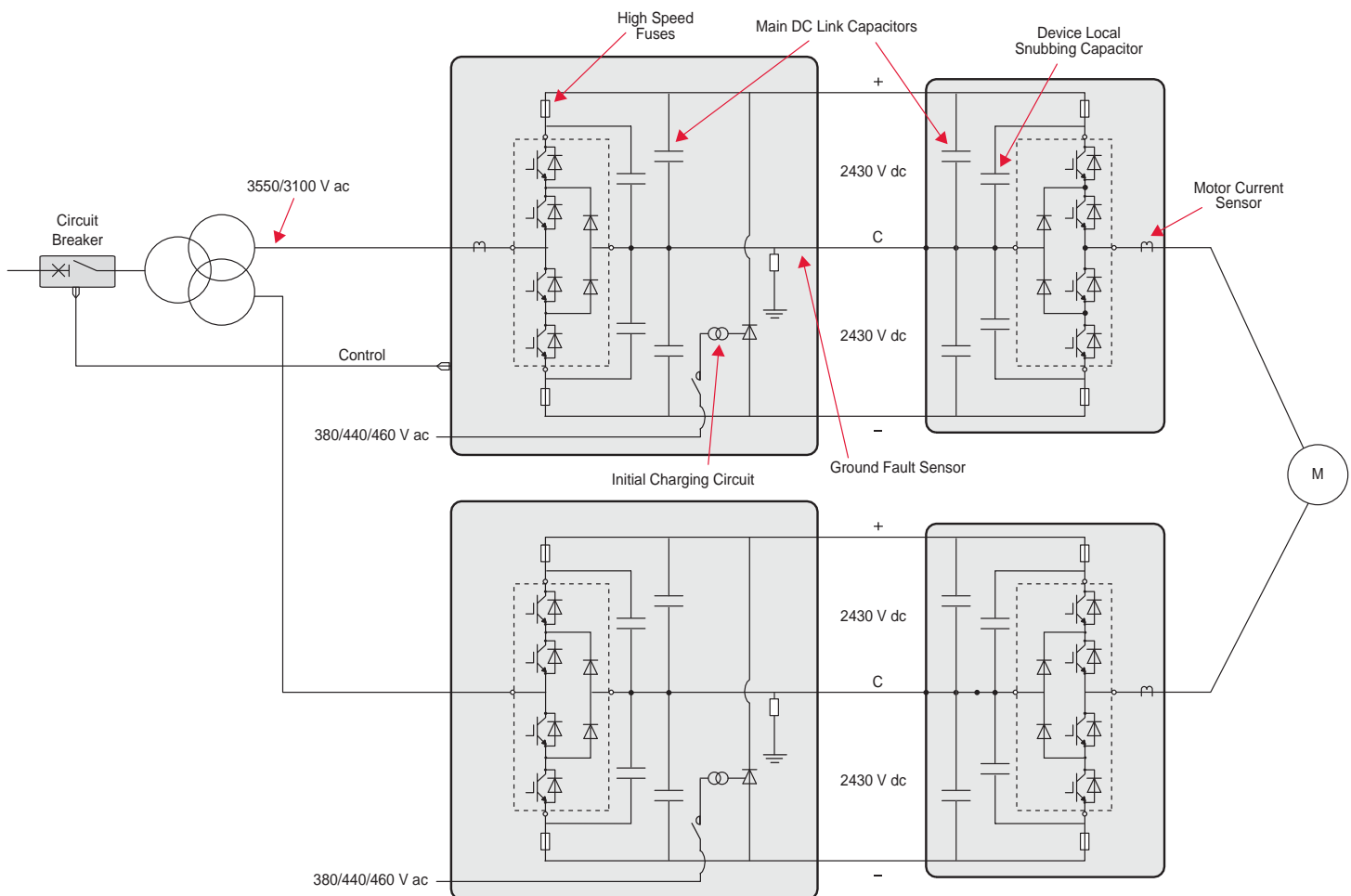

Drive Specifications

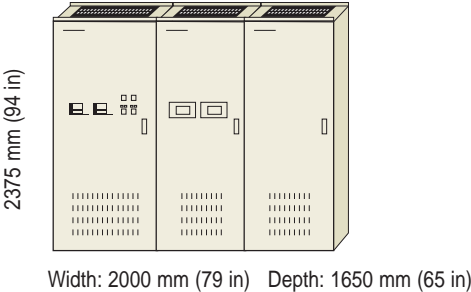
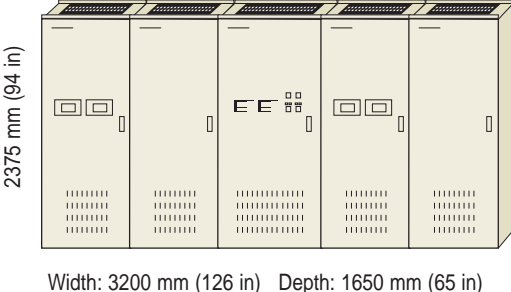
	Banks	Frame kVA	Weight kg (lbs)	Control Power kVA	Motor Current A ac	Allowable Overload % (60 sec)
 <p>2375 mm (94 in)</p> <p>Width: 2000 mm (79 in) Depth: 1650 mm (65 in)</p>	1	3000	3300 (7275)	3.0	510	150
					437	175
					382	200
					340	225
					306	250
 <p>2375 mm (94 in)</p> <p>Width: 3200 mm (126 in) Depth: 1650 mm (65 in)</p>	2	6000	5800 (12787)	6.0	1020	150
					874	175
					764	200
					680	225
					612	250

Notes

- Above dimensions do not include channel-base support – 50 mm (2 in).
- Above is for induction motor drive, additional field exciter panel is required for synchronous motor.
- Required maintenance access space is 2000 mm (79 in) at front and 1500 mm (59 in) at rear of panel, air exhaust space is 1000 (40 in) above panel.
- For separate cooling type, flange connection (JIS-10K40A) is required at bottom rear of inverter and converter panels.
- Outside cooling water inlet temperature is 10-32°C.
- Amps are standard values; they will vary with voltage, type of load, and other control.
- Control power is 50 or 60 Hz, 200/220 V, 3.0 kVA per bank.
- Converter and inverter cable entrance is from bottom.
- Indoor environment: no corrosive gas or dust, altitude below 1000 m, ambient temperature 0-40°C, relative humidity 5-95%, no condensation.
- This initial charge inrush is 42 kVA for 10 seconds for each bank.

Modular Assembly

Three-Level Phase Leg Assembly for Both Converter and Inverter

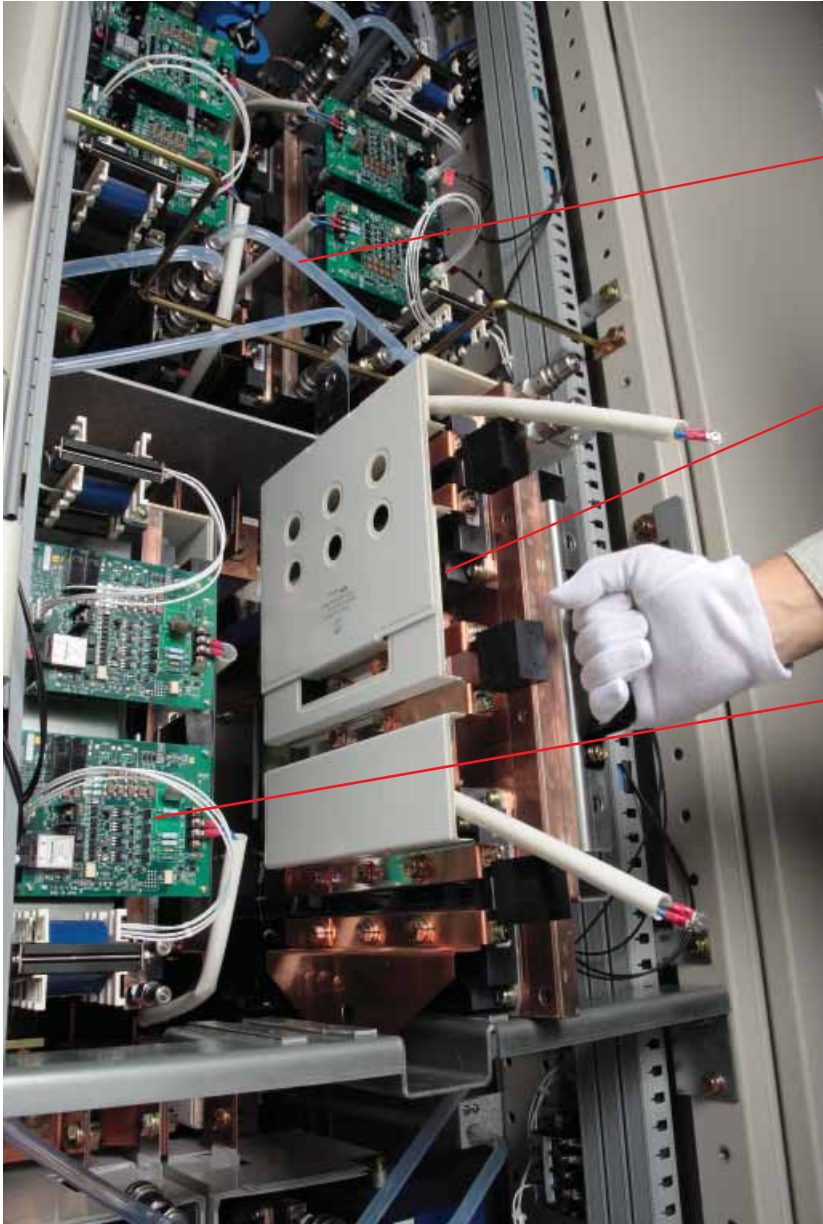

Flexible Water Cooling Tubes are easy to manage when performing maintenance.

Slide-out Half Power Leg allows easy manipulation of power modules without the need for special tools or lifting devices.

IGBT Gate Drive

Self-sealing quick couplers allow the water cooling circuit to be disconnected without tools or water loss.

Dual IGBT Assembly common to inverter and converter section.

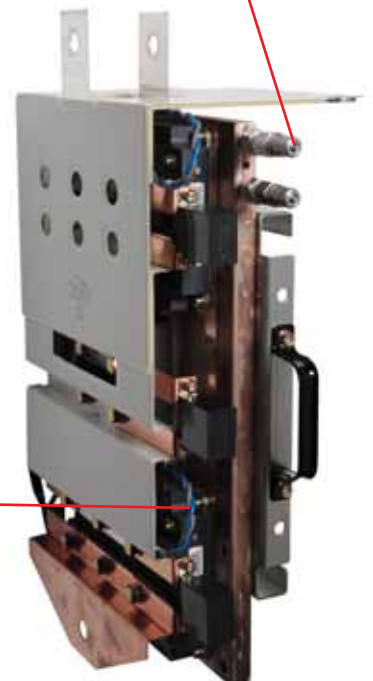



Environmental (Inverters and Converters)

Operating Air Temperature	0 to 40°C (32 to 104°F) at rated load 0 to 50°C (32 to 122°F) with derating
Storage Temperature	-20 to 55°C (-13 to 131°F)
Humidity	5 to 95% relative humidity Non-condensing
Altitude	0 to 1000 m above sea level
Vibration	10-50 Hz, <0.5 G
Operating Water Temperature	10°C - 32°C at inlet 10°C - 35°C at inlet with derate Outlet temperature is inlet + 6°C



Motor Control

With Speed Sensor (Resolver or Encoder)

- Speed regulator accuracy: +/- 0.01%
- Maximum speed response: 60 rad/sec
- Torque linearity: +/- 10% Synchronous motors
- Torque linearity: +/- 3% with temperature sensor
+/- 10% without temperature sensor
- Maximum Torque current response: 600 rad/sec
- Torque range: 0-400% of rated motor torque
- Maximum flux control range: 20%-100%

} Induction Motor

Without Speed Sensor (Induction Motor Only)

- Speed regulator accuracy: +/- 0.1% with temperature sensor
+/- 0.2% without temperature sensor
- (Using 1% slip motor at rated flux)
- Maximum speed regulator response: 20 rad/sec
- Minimum continuous speed: 3%
- Torque linearity: +/- 10%
- Maximum Torque current response: 600 rad/sec
- Torque range: 0-150% of rated motor torque
- Maximum flux control range: 75%-100%

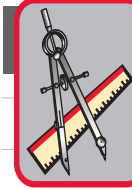

Mechanical (Inverters and Converters)

Enclosure	IP 20 (NEMA 1), JEM-1267, IEC-60529
Cable Entrance	Bottom
Wire Colors	Per CSA/UL and CE
Short Circuit Ratings	100 kA for ac and dc buswork 25 kA for control power
Acoustic Noise	66-68 dB @ 150% OL, 1 m from cabinet in all directions, 1.5 m in height above the floor



Power Input/Output

Input Voltage	3550 V for Fixed Pulse Pattern type 3100 V for Carrier Comparison type
Input Voltage Variation	+/- 10%, Continuous operation below nominal requires derate
Input Frequency	50/60 Hz
Input Chopping	Approx. 500 Hz
Input Harmonics	IEEE 519 Compliant
Control Power	Control and Blowers 180-220 Vac, 50 Hz 3-Phase 198-242 Vac, 60 Hz 3-Phase Pumps and Precharge 380-460 Vac, 50/60 Hz 3-Phase
Displacement Power Factor	0.98
Output Voltage	3400 V max
Output Frequency	0-60 Hz Continuous operation below 0.4 Hz requires derate
Output Chopping Frequency	512 Hz
Efficiency	98.5% at rated load

Water Conditioning Equipment



Water conditioning control panel continuously monitors the status of the water system. Separate fault indications help find and fix problems fast.

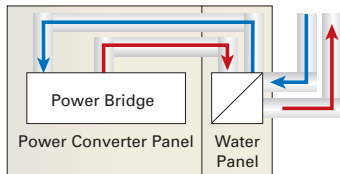

Integrated water system has internal plumbing for de-ionized cooling loop.

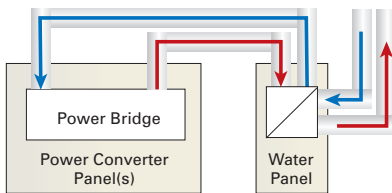

Separate type cooling has field-installed plumbing for de-ionized cooling loop.



Water to water heat exchanger keeps the de-ionized system isolated from the plant water supply.

Surge tank absorbs water during pump transients and indicates the internal cooling loop water level.

De-ionizer removes contaminants for the internal cooling loop.

Redundant pumps keep the system running even if one pump fails

Type	Capacity	Width mm (in)	Depth mm (in)	Height mm (in)	Weight w/ water kg (lbs)	kVA	Notes
Integrated with Lineup	60 kW	800 (32)	1050 (42)	2375 (94)	900 (1980)	5	Capacity for one converter/inverter, (1 bank) Plant water required: 108 l/min (29 gal/min)
Separate Cabinet	120 kW	800 (32)	1050 (42)	2375 (94)	1000 (2200)	10	Capacity for two converters/inverters, (2 bank) Plant water required: 216 l/min (57 gal/min)

Advanced PWM Technology

Advanced PWM control brings enhanced efficiency and reduced harmonics to TDrive-50 systems. Fixed pulse pattern gate control uses optimum gating sequences to almost eliminate switching losses in the IGBT device. Gating sequences are pre-computed for the control rather than computed at runtime. The result is performance that reduces losses and harmonics.

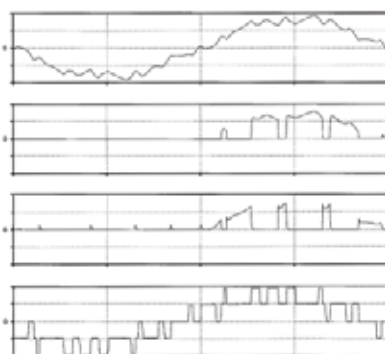

Conventional PWM

Input Current



Diode Current

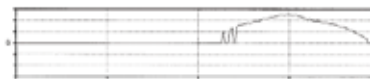

IGBT Current

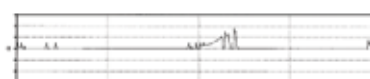

Output Voltage



Fixed Pulse Pattern Control

Field Supply Specifications

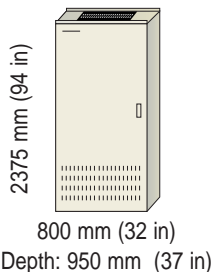
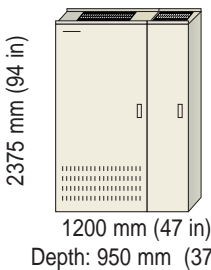
	Frame	Weight kg (lbs)	Control Power kVA	Voltage Vac (Vdc)
 <p>2375 mm (94 in) 800 mm (32 in) Depth: 950 mm (37 in)</p>	1200	300 (660)	0.5	500 (675)
 <p>2375 mm (94 in) 1200 mm (47 in) Depth: 950 mm (37 in)</p>	2100	700 (1540)	0.5	500 (675)

Type	Overload Time (sec)	Field Exciter Continuous Current Rating, dc Amps											
		50 Hz						60 Hz					
		150%	175%	200%	225%	250%	300%	150%	175%	200%	225%	250%	300%
1200 A	10	1320	1200	1100	1010	940	810	1360	1240	1130	1040	960	830
	30	1230	1100	1000	900	820	710	1280	1130	1020	915	845	720
	60	1180	1040	920	830	760	645	1205	1060	945	850	775	660
	120	1120	980	860	760	690	585	1160	1000	885	790	710	590
2100 A	10	2376	2160	1980	1818	1692	1458	2448	2232	2034	1872	1728	1494
	30	2214	1980	1800	1620	1476	1278	2304	2034	1836	1647	1521	1296
	60	2124	1872	1656	1494	1368	1161	2169	1908	1701	1530	1395	1188
	120	2016	1764	1548	1368	1242	1053	2088	1800	1593	1422	1278	1062

2100 Frame Field Supply

AC Leg
Fuses protect
power bridge
from faults on
the ac line

Autonomous
Crowbar
prevents
dangerous
motor
voltages from
developing
under
certain fault
conditions

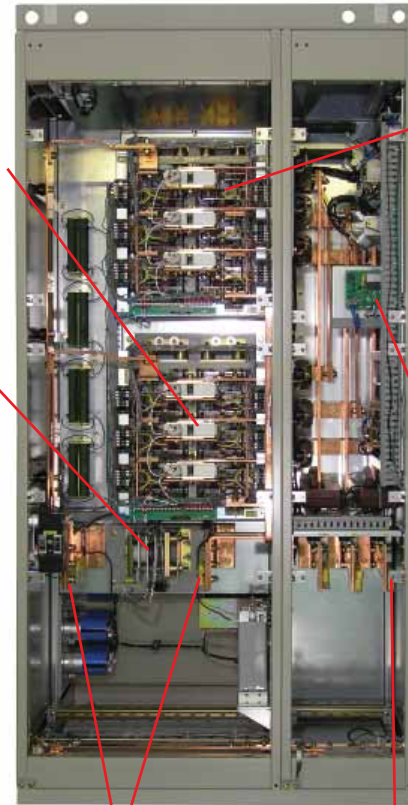

Main
Power
module.
One
module is
applied for
the 1200A
supply
and two
modules for
the 2100A
model.

Ground
Fault
detection
module
provides
indication
of insulation
failure

DC Field
Connection
Bus

AC Connection Bus.
AC voltages up to
500 Vac can be
connected depending
on required voltage

Enhanced Converter Technology

TMdrive-50 VAR Control

The TMdrive-50 converter can be configured in two modes, providing VAR Control within the limits of its current capacity.

One mode is the conventional PWM type normally set to hold unity power factor for all load conditions (shown in red).

Another mode is the Fixed Pattern type, providing voltage stability, improved harmonics and efficiency. The Fixed Pattern mode stabilizes line voltage by providing system VARs when line voltage is low and drawing VARs from the system when the voltage is high. By convention, VARs from the system are (+) and cause the line voltage to drop while VARs from the converter are (-) and cause the line voltage to rise. The relationship of line voltage, loads MW and converter MVAR is shown by the blue voltage lines depending on the measured line voltage.

MVA vs. MW and Voltage

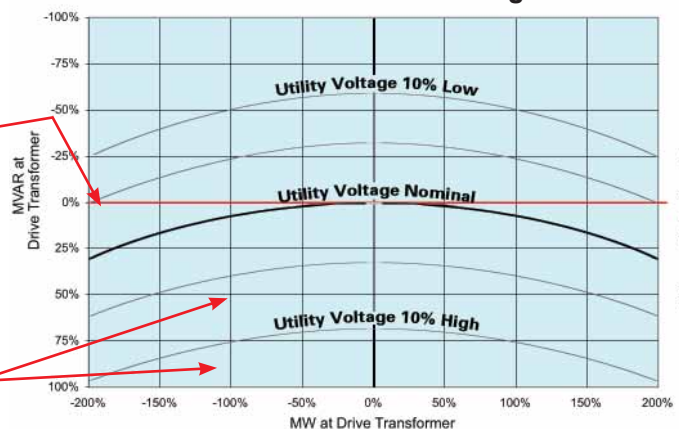

Application Examples

Applying the TMdrive-50 Starts With the Motor Design

Consideration must be given to motor design when applying the TMdrive-50. A primary constraint is the motor terminal voltage. It is important that the motor terminal voltage does not exceed 3400 Vac under any operating condition. Reserving voltage margin correctly is critical to success. Detailed motor design data is needed for correct application.

OL_V Overload derate. The rated motor voltage over the terminal voltage of the motor at maximum applied overload. Motors with no overload use 1.0.

ST_V Field forcing margin needed when applying synchronous motors. Apply 0.94 for synchronous motor systems.

RP_V Reduction in maximum voltage due to the dc Bus ripple of the drive at low frequencies. If the base frequency is below 5 Hz then this derate is 0.97, otherwise it is 1.0.

SP_V Speed margin. For motors that run above base speed this is the ratio of the terminal voltage at base speed over the terminal voltage at top speed under maximum overload at each point. Other motors use 1.0.

$$\text{Maximum Rated Motor Voltage} = 3400 \times \text{OL_V} \times \text{RP_V} \times \text{ST_V} \times \text{SP_V}$$

Experience has shown that the following maximum rated motor voltages apply based on the type of motor and the application.

Induction (Maximum Voltage at max OL and top speed)	Synchronous Maximum Rated Motor Volts	Rated Motor Frequency	Overload Requirement	Example Application
3400	3300	60 Hz	100%	Pump or Fan
3300	3200	30 Hz	200%	Mine Hoist
3200	3100	5 Hz	225%	Mill Stand

TMdrive-50 Notes

- Allocate a minimum of 1000 mm (40 in) above cabinet for fan maintenance.
- Power rating data assumes ambient temperature of 0-40°C (32-104°F), altitude up to 1000 m (3280 ft) above sea level.
- The specified current ratings are continuous to which the indicated overload may be applied for a maximum of 60 seconds.
- Each cabinet requires 3-phase control power.
- For high performance torque regulation, a temperature sensor is mounted in the motor.
- All TMdrive-50 cabinets require 1500 mm (59 in) back access for connections and maintenance.
- Speed and current regulator responses are computed per the adjacent figure in radians/s. Speed regulator responses shown are maximum available. Actual response will be limited by drive train mechanical conditions. Accuracy and linearity specifications shown are as measured under controlled conditions in our lab and while typical may not be achievable in all systems.
- Water connections for separate type cooling systems are located near the floor in the rear of power converter cabinets. The flange is 1500 mm JIS-10K40A. Stainless piping is required for plumbing of the de-ionized loop.
- dc Bus bar included in lineups is rated for one inverter only. For common bus systems, converters and inverters are arranged so that this limitation is not exceeded.
- When output or input reactors are used to parallel systems then the dc Buses of those systems must be connected together.
- Systems that share a common dc Bus must have the same winding configuration for their converter transformer secondaries.
- Field supply enclosures are typically installed directly behind control enclosures within the lineup.
- TMdrive-P50 converters require a minimum of 15% total input impedance.
- Systems with a base frequency below 5 Hz may require additional 800 mm (32 in) capacitor panels for each dc link.

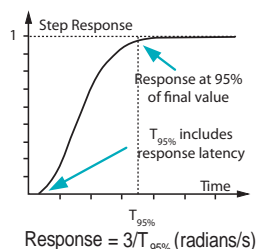

Inverter Example

When specifying an inverter, start from the process requirements and work through the motor to the inverter. The following example illustrates this process.

1 Define process requirements.

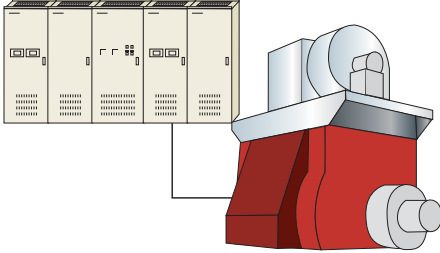

$kW_{\text{Shaft}} = 4000 \text{ kW (5360 hp)}$
500 rpm

The motor delivers constant torque from zero to base speed of 500 rpm and 4000 kW (5360 hp).

Duty cycle requires 150% for 10 sec. but has rms duty cycle of 4000 kW (5360 hp).

2 Select motor based on process requirements and compute required inverter kVA.

- 4000 kW (5360 hp)
- 500 rpm, 3100 V
- Efficiency = 0.965
- Power factor = 1.00
- Service factor = 1.0
- Synchronous

$$I_{\text{ac Inverter}} = \frac{kW_{\text{Shaft}} \times 1000 \times SF_{\text{Mtr}}}{\sqrt{3} \times V_{\text{Motor rated voltage}} \times \text{Eff}_{\text{Mtr}} \times \text{PF}_{\text{Mtr}}}$$

$$= \frac{4000 \times 1000 \times 1.0}{\sqrt{3} \times 3150 \text{ V} \times 0.965 \times 1.0}$$

$$= 760 \text{ amps}$$

3 Compute continuous current requirements for the inverter based on the selected motor.

4 Select inverter based on continuous current and overload requirements.

Scan the 150% entries in the inverter tables for a frame where the continuous current rating exceeds 760 amps. The **6000 frame** meets this criterion (**1020 amps**) and is appropriate for this application.

Current A ac	Allowable Overload %
1020	150
	175
	200
	225
	250

A Common Control To Reduce Cost Of Ownership

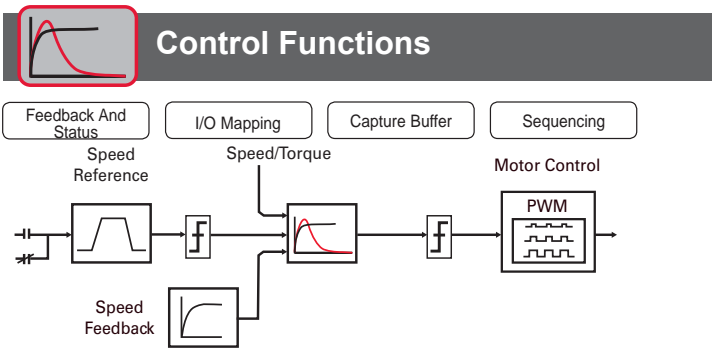

I/O Interface

Digital Inputs	+24 V dc 24-110 V dc 48-120 V ac	<ul style="list-style-type: none"> • Opto-coupled 20 mA • Quantity 6 configurable • Opto-coupled 10 mA • Quantity 1 configurable mapping • Quantity 1 dedicated mapping
Digital Outputs	+50 V dc	<ul style="list-style-type: none"> • Open collector 70 mA • Quantity 6 user defined
Analog Inputs	10 V, 4-20 mA	<ul style="list-style-type: none"> • Quantity 2 ±10 V or 4-20 mA - Differential 8 kΩ input impedance - 12-bit resolution • Optional Quantity 2 ±10 V - 12 bit resolution (Optional for Inverters only)
Analog Outputs	D/A 10 V	<ul style="list-style-type: none"> • Quantity 4 ±10 V, 10 mA max • User defined • 12-bit resolution
Speed Feedback Resolver Input		<ul style="list-style-type: none"> • Excitation frequency of 1 or 4 kHz • Source for resolvers is Tamagawa: www.tamagawa-seiki.co.jp
(Induction motor only) Speed Feedback Encoder Input		<ul style="list-style-type: none"> • A quad B with marker • Maximum frequency of 100 kHz • Differential 5 or 15 V dc • 5 or 15 V dc at 200 mA supply
Speed Tach Follower Output		<ul style="list-style-type: none"> • Maximum frequency of 10 kHz • External 15-24 V dc at 100 mA max
Motor Temp. Feedback		<ul style="list-style-type: none"> • High-resolution torque motor temperature feedback • 100 Ω positive temperature coefficient RTD or other sensor using optional signal conditioning module

Instrumentation Interface

Configuration

- Direct Ethernet connection of TMdrive-Navigator to the drive
- Drive Navigator connection to the drive using TC-net via the nv controller

Meter Outputs

- Motor current A and B, ±10 V
- Quantity 5 configurable, ±10 V, 8-bit resolution

LAN Interface Options

TC-net I/O	<ul style="list-style-type: none"> • 8 words in/out • 10 words in/19 out option
Ethernet Global Data (EGD)	• 10 words in/out
Profibus-DP	• 10 words in/out
Modbus RTU	• 10 words in/out
ControlNet	• 10 words in/out
DeviceNet	• 4 words in, 10 words out

TOSLINE-S20 and ISBus legacy LANs can also be supported on request. Note: 1 word = 16 bits

Operator Interfaces

Standard Display (Inverters and Regenerative Converters)

Three-digit display alternates between speed and current while running, or a fault code when there is an error.



Optional analog meters can be supplied in addition to either the standard or enhanced display. Up to four meters can be provided.



Three LEDs give a quick indication of the status of the unit



RJ-45 Ethernet port is used for local toolbox connection

Interlock button disables the drive

LED Indication

Ready	On when the unit is ready to run
Running	On when the unit is running
Alarm/Fault	Blinking LED indicates alarm condition, while solid LED indicates a fault

Keypad Option (Inverters and Regenerative Converters)

High Function Display

- LCD backlight gives great visibility and long life
- Bar graphs, icons, menus, and digital values combine to provide concise status information, often eliminating the need for traditional analog meters



Easy-to-understand navigation buttons allow quick access to information without resorting to a PC-based tool

RJ-45 Ethernet port is used for the local toolbox connection

Switch to local mode and operate the equipment right from the keypad

Instrumentation Interface

- Two analog outputs are dedicated to motor current feedback
- Five analog outputs can be mapped to variables for external data logging and analysis

Interlock button disables the drive

TMEIC AC Drives Offer Complete Coverage

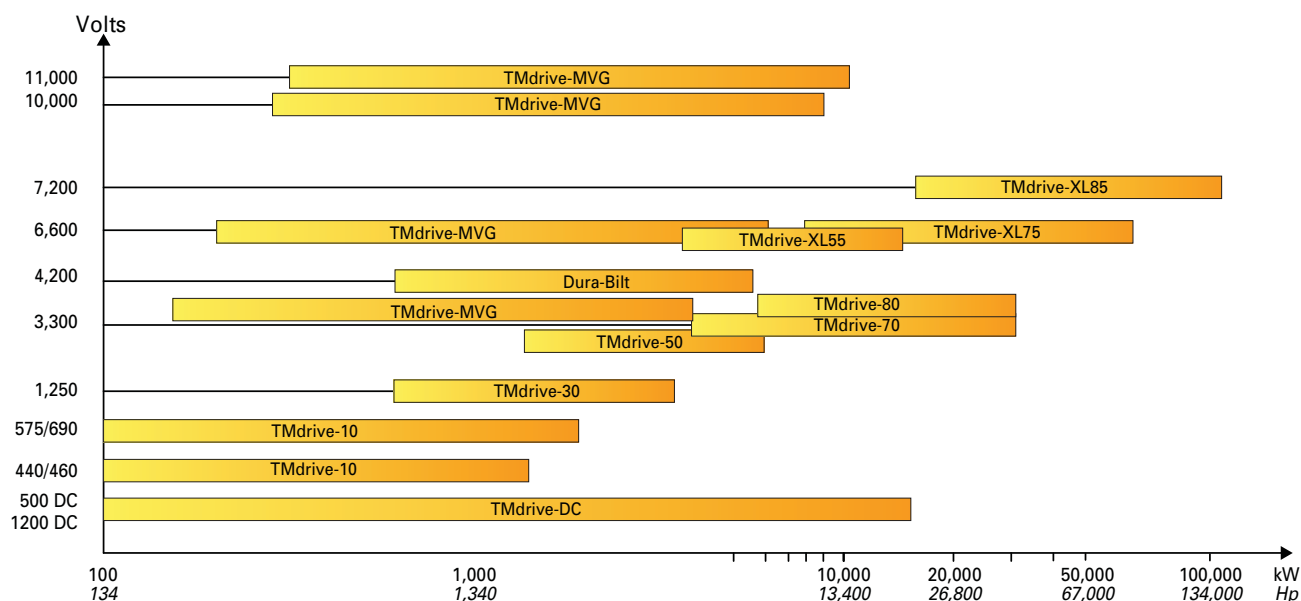

TMEIC Corporation

Office: 1325 Electric Road, Roanoke, VA, 24018, USA
 Mailing: 2060 Cook Drive, Salem, VA, 24153, USA
 Tel.: +1-540-283-2000; Fax: +1-540-283-2001
 Email: info@tmeic.com; Web: www.tmeic.com

TMEIC Corporation - Houston Branch

2901 Wilcrest Dr., Houston, TX 77042, USA
 Tel.: +1-713-784-2163; Fax: +1-713-784-2842
 Email: OilGas@tmeic.com; Web: www.tmeic.com

TMEIC Power Electronic Products Corporation

13131 W. Little York Road, Houston, Texas 77041, USA

Toshiba Mitsubishi-Electric Industrial Systems Corporation

Tokyo Square Garden
 3-1-1 Kyobashi, Chuo-kyo, Tokyo, 104-0031, Japan
 Tel.: +81-0-3327-5511
 Web: www.tmeic.co.jp

TMEIC Europe Limited

6-9 The Square, Stockley Park, Uxbridge, Middlesex,
 United Kingdom, UB7 7LT
 Tel.: +44 870 950 7220; Fax: +44 870 950 7221
 Email: info@tmeic.eu; Web: www.tmeic.com/Europe

TMEIC Industrial Systems India Private Limited

Unit # 03-04, Third Floor,
 Block 2, Cyber Pearl, HITEC City, Madhapur,
 Hyderabad, 500081, Andhra Pradesh, India
 Tel.: +91-40-44434-0000; Fax: +91-40-4434-0034
 Email: inquiry_india@tmeic.com; Web: www.tmeic.in

Toshiba Mitsubishi-Electric Industrial Systems Corp (Beijing)

21/F, Building B, In.do Mansion, 48 Zhichunlu A, Haidian
 District, Beijing 100098, PRC
 Tel.: +86 10 5873-2277; Fax: +86 10 5873-2208
 Email: sales@tmeic-cn.com

TMEIC – Sistemas Industriais da América do Sul Ltda.

Av. Paulista, 1439 cj72
 Bela Vista, CEP:01311-200
 São Paulo/SP, Brasil
 Tel: +55-11-3266-6161; Fax: +55-11-3253-0697

Innovation Series is a trademark of General Electric Company.

TMdrive is a registered trademark of TOSHIBA MITSUBISHI-ELECTRIC INDUSTRIAL SYSTEMS CORPORATION.

TMEIC is a registered trademark of TOSHIBA MITSUBISHI-ELECTRIC INDUSTRIAL SYSTEMS CORPORATION.

All other products mentioned are registered trademarks and/or trademarks of their respective companies.

All specifications in this document are subject to change without notice. The above brochure is provided free of charge and without obligation to the reader or to TMEIC Corporation. TMEIC Corporation does not accept, nor imply, the acceptance of any liability with regard to the use of the information provided. TMEIC Corporation provides the information included herein as is and without warranty of any kind, express or implied, including but not limited to any implied statutory warranty of merchantability or fitness for particular purposes. The information is provided solely as a general reference to the potential benefits that may be attributable to the technology discussed. Individual results may vary. Independent analysis and testing of each application is required to determine the results and benefits to be achieved from the technology discussed.

If you have any questions regarding your project requirements, please contact TMEIC Corporation at 540-283-2000.